



# Thank You!

---

**You have successfully downloaded your document from Workbenchmagazine.com. Below are some tips for Trouble-Free Printing**

- 1)** Clear printer memory. If you are unable to print this document, turn off your printer for at least 15 seconds and try again.
- 2)** Print two or three pages at a time. If clearing the printer memory didn't help, try printing only two or three pages at one time, rather than sending the entire file
- 3)** If a document is required to be at an accurate scale set the page scaling option to "none" in your printer settings.
- 4)** Get advanced printer help. Visit Adobe Support for instructions in troubleshooting common printer problems.

<http://www.adobe.com/support/techdocs/316508.html>



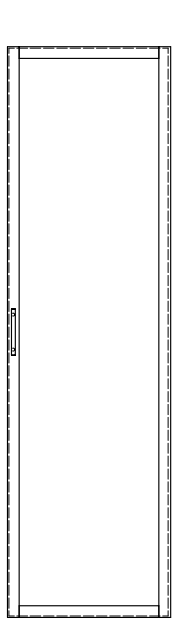

MIRROR DOOR

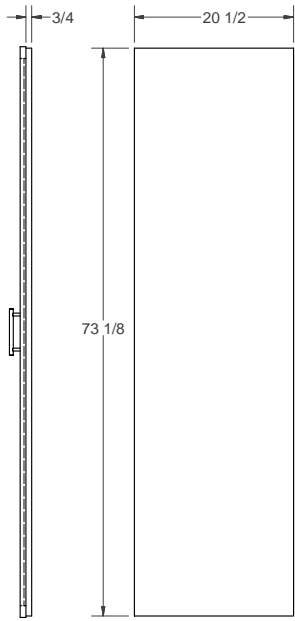

MIRROR BACKER

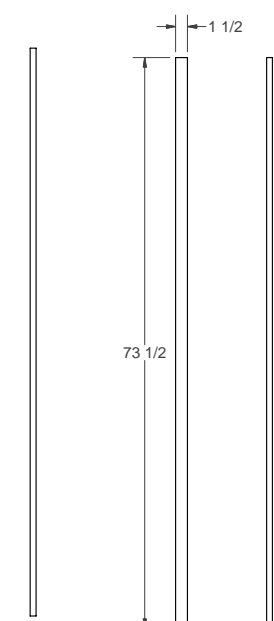

DOOR STILE TRIM

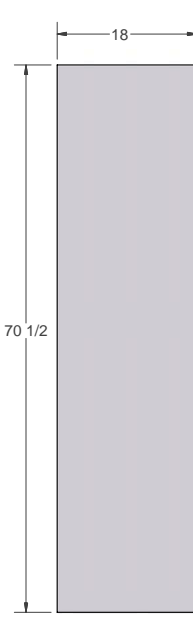

MIRROR



PIANO HINGE

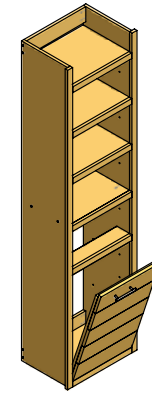

HAMPER OPT.

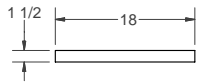

DOOR RAIL TRIM



CLEAT FRONT

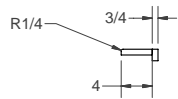

HAMPER CLEAT

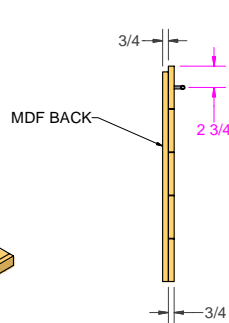
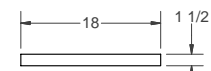

MDF BACK

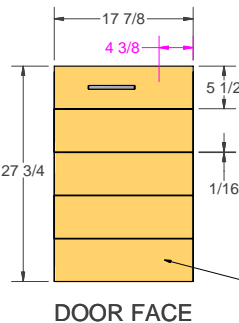

DOOR FACE

SOLID WOOD FACES

CLEAT TO BE FIXED FROM SIDES

1/4" RARE EARTH MAGNETS FOR DOOR CATCH

CHAIN CONNECTED TO DOOR AND CAB.

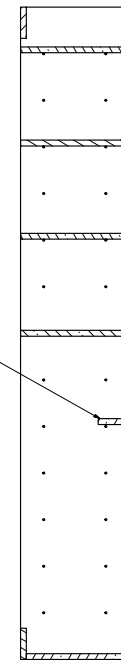

SECTION G-G

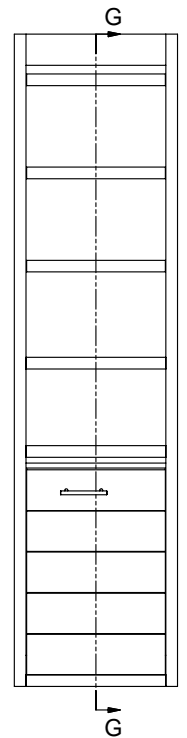

G

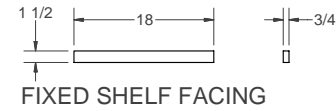
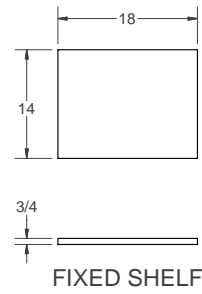
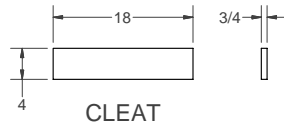
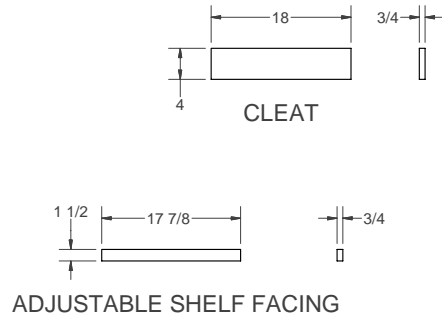
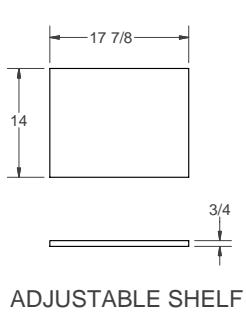
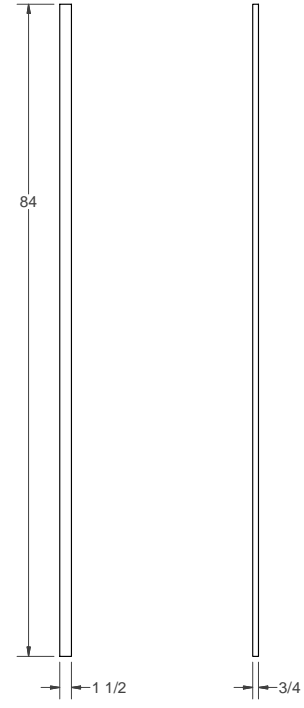
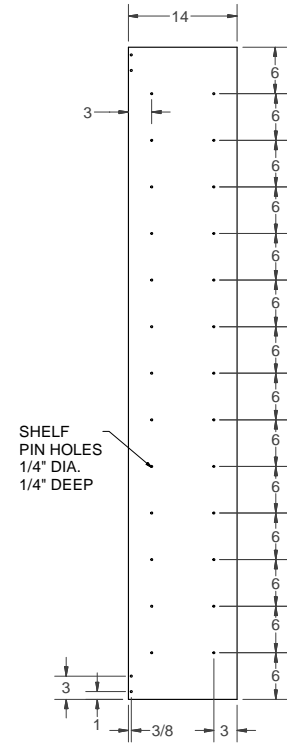
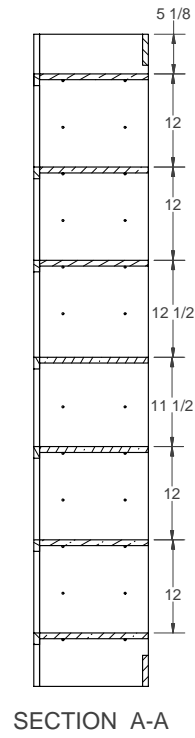
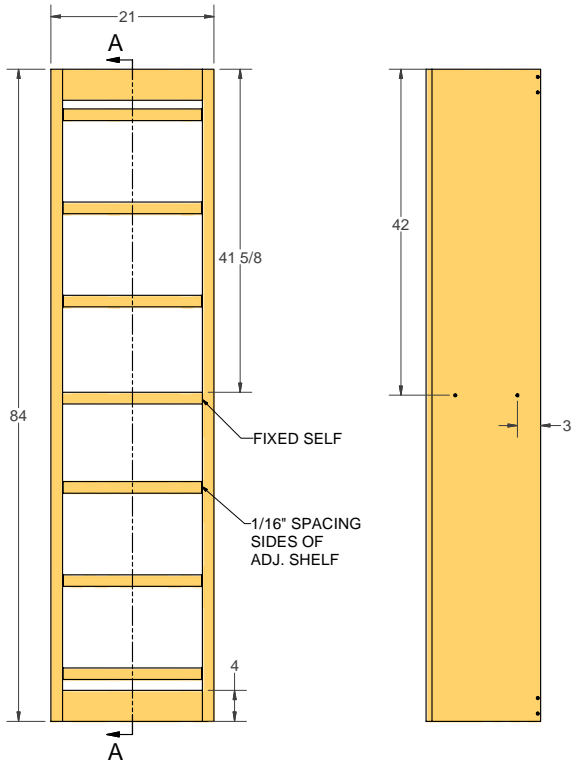

TOWER PANEL

PANEL FACING

SECTION A-A

ADJUSTABLE SHELF

ADJUSTABLE SHELF FACING

CLEAT

FIXED SHELF

FIXED SHELF FACING

