



# Thank You!

---

**You have successfully downloaded your document from Workbenchmagazine.com. Below are some tips for Trouble-Free Printing**

- 1)** Clear printer memory. If you are unable to print this document, turn off your printer for at least 15 seconds and try again.
  
- 2)** Print two or three pages at a time. If clearing the printer memory didn't help, try printing only two or three pages at one time, rather than sending the entire file
  
- 3)** If a document is required to be at an accurate scale set the page scaling option to "none" in your printer settings.
  
- 4)** Get advanced printer help. Visit Adobe Support for instructions in troubleshooting common printer problems.

<http://www.adobe.com/support/techdocs/316508.html>

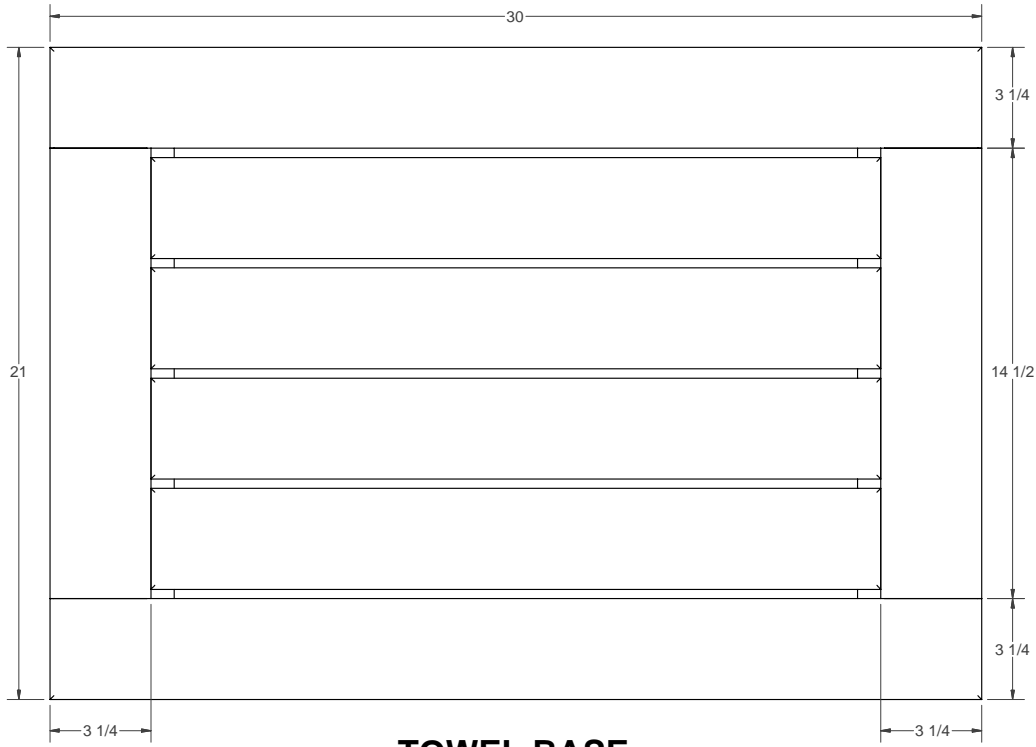

**TOWEL BASE  
(TOP VIEW)**

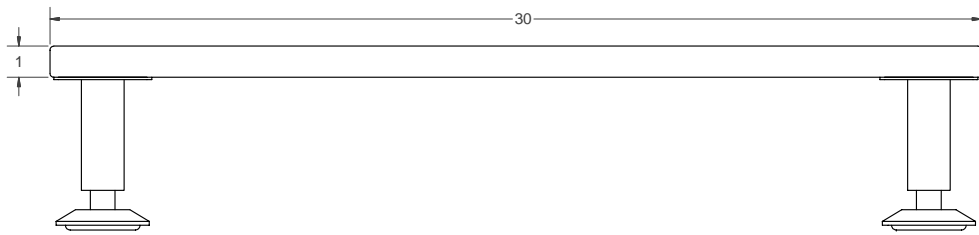

**TOWEL BASE  
(FRONT VIEW)**

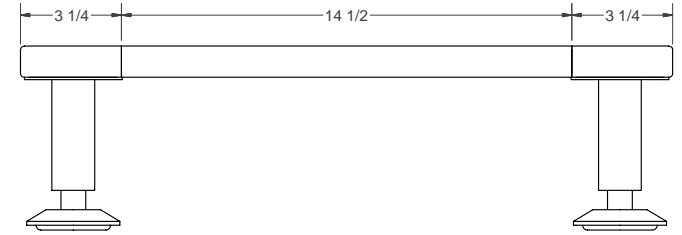

**TOWEL BASE  
(SIDE VIEW)**

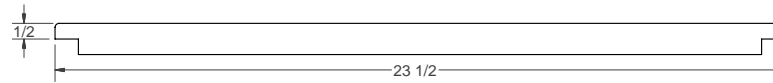
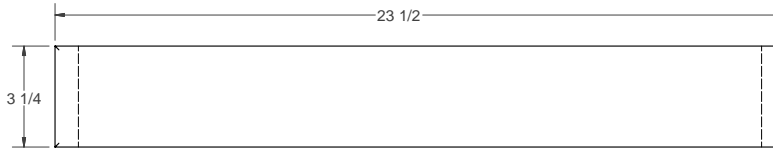
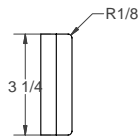
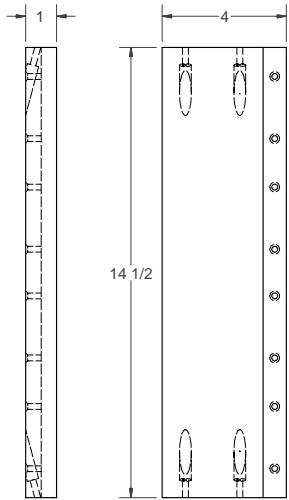
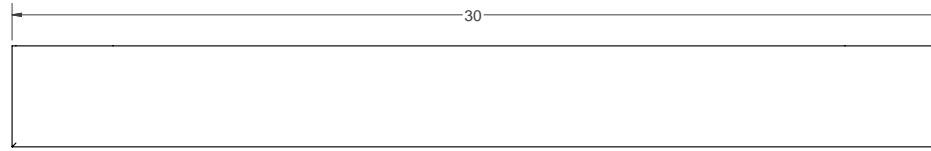
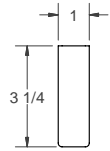

**SLAT  
(NEED 4)**

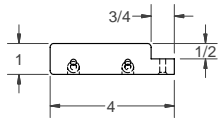
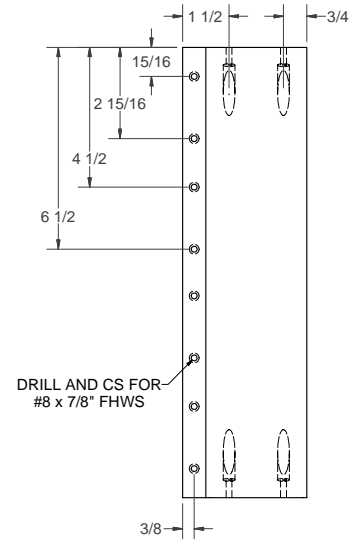

**TOWEL BASE  
FRAME RAIL**

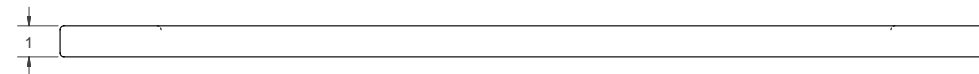
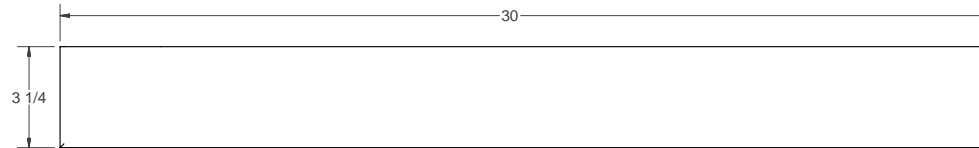

**TOWEL BASE FRAME STILE**